

GNT503020

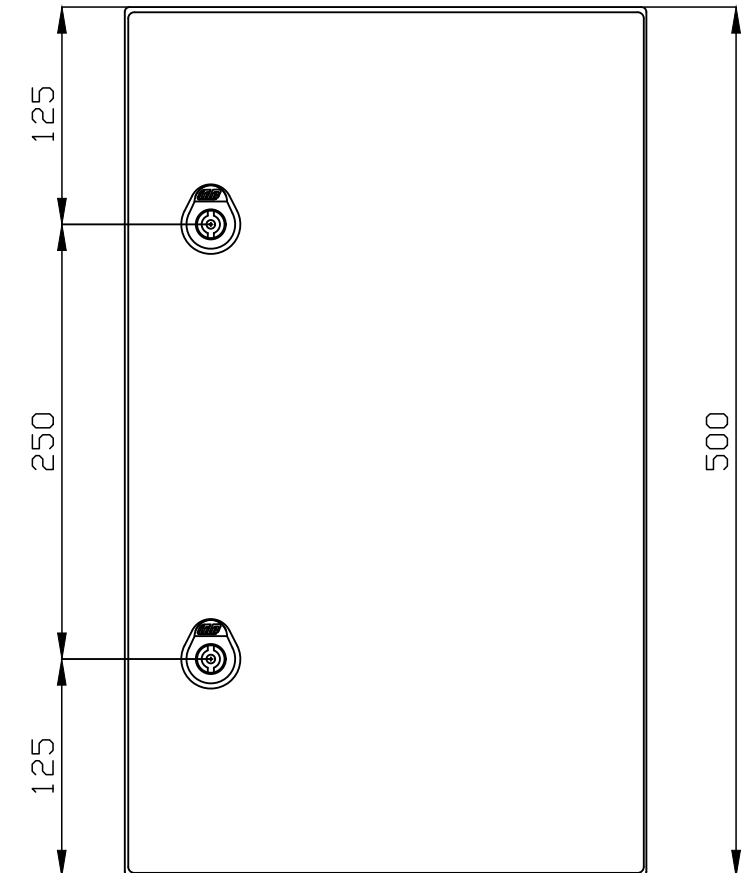

GN503020

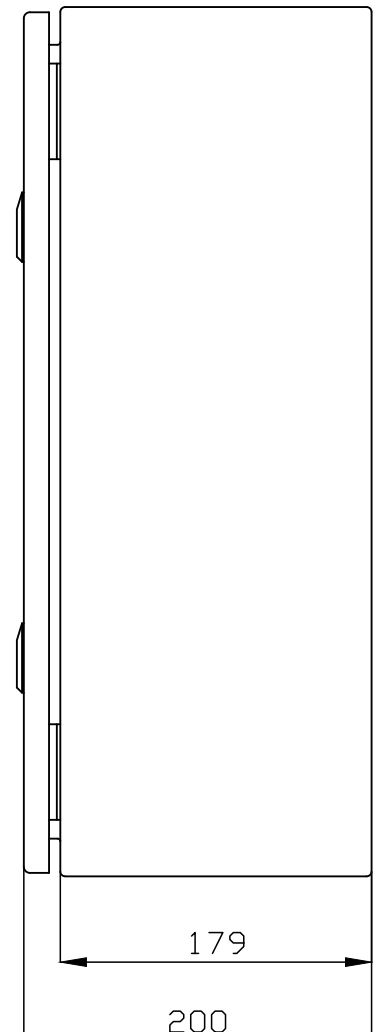
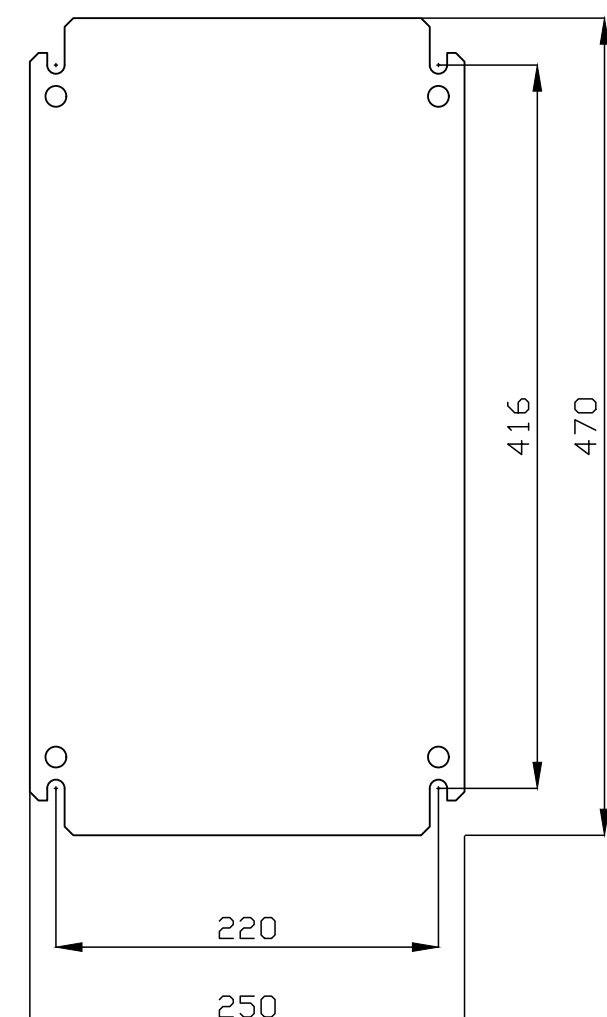
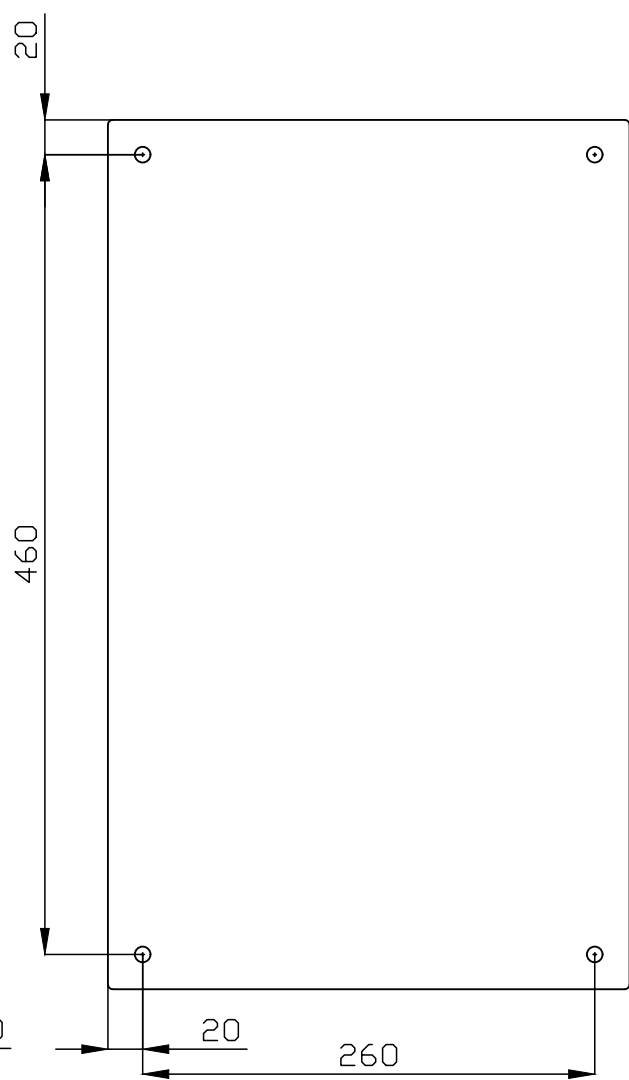
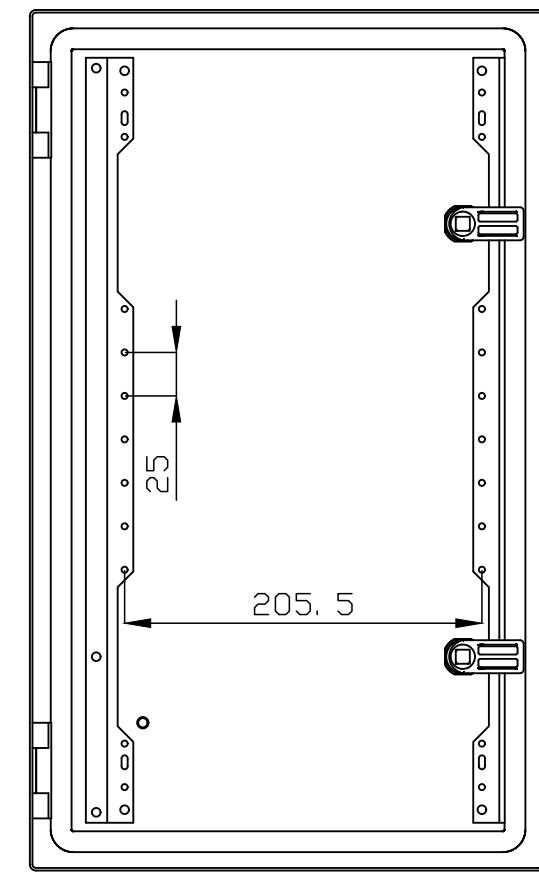
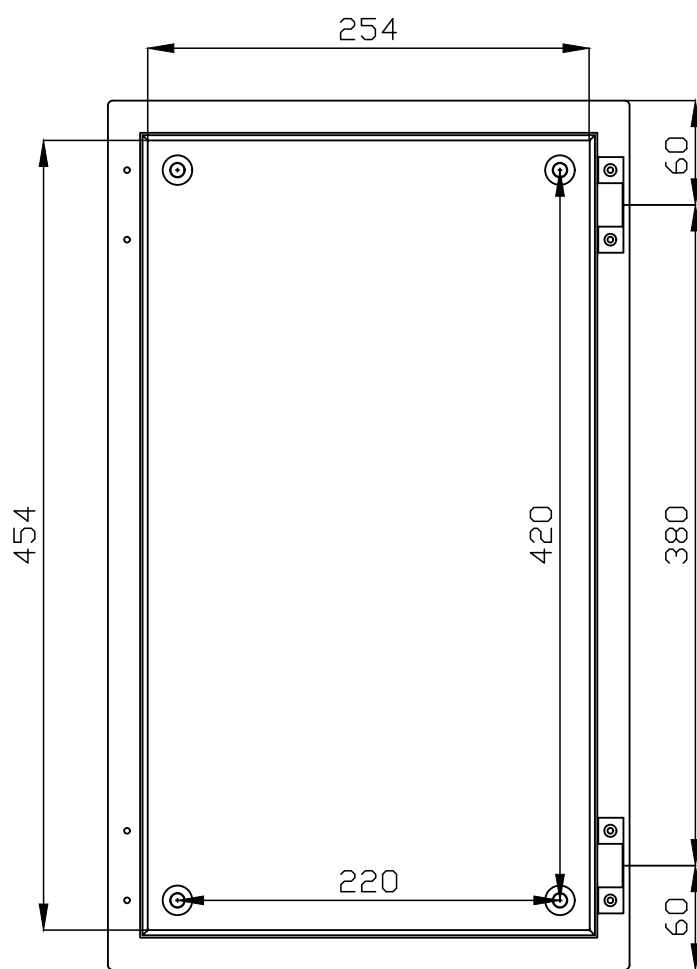
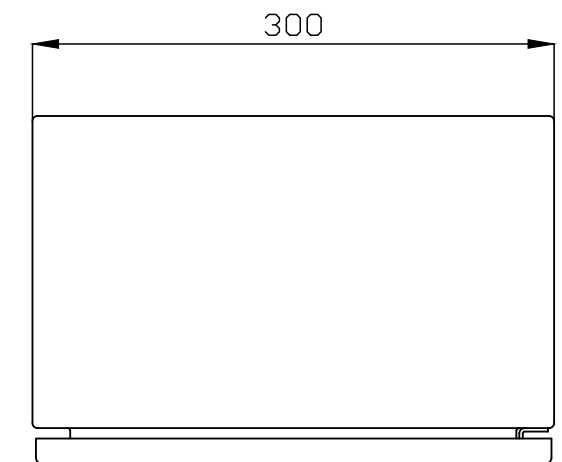

PLACA DE MONTAJE NO INCLUIDA EN REF. */SP*
MOUNTING PLATE NOT INCLUDED IN REF. */SP*

MODIFICADO MODIFIED					DESCRIPCION DEL CAMBIO / CHANGE DESCRIPTION	PROYECTO/PROJECT
FIRMA / SIGNATURE DIGITAL	NOMBRE NAME	FECHA DATE	Nº EDIC. MODIF.			ARGENTA
APROBADO CHECKED	C.VICENTE	04/05/2020		DESCRIPCION / DESCRIPTION		SUSTITUYE/REPLACE
DIBUJADO DRAWN	C.LÓPEZ	04/05/2020		GN/GNT503020		EDICION / EDITION Nº 1
HOJA 1 DE 1 SHEET 1 OF 1		TOLERANCIAS GENERALES GENERAL TOLERANCES		CODIGO DE PLANO / DRAWING CODE		
TAMAÑO / ESCALA / SIZE / SCALE		EN 22768-mK		500.06.020		
A2		1:1				

Queda terminantemente prohibida la reproducción o divulgación, total o parcial, de este plano sin previa autorización por escrito de I División Eléctrica S.A.
Total or partial reproduction or disclosure of this document is strictly forbidden without the prior written approval of I División Eléctrica S.A.

